

# FLAT TOP TOWER CRANE

**Specifications:**

- ▶ Max jib length: 65,00 m
- ▶ Capacity at max length: 2,30 t
- ▶ Max capacity: 10,00 t



Power Plus

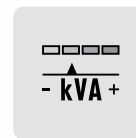

Power Match



Easy Setup

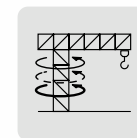

T-Torque



T-Link

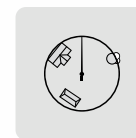

Zoning

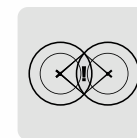

Anticollision

**WORKS FOR YOU.™**

# KEY

## Legenda · Zeichenerklärung · Légende · Leyenda · Legenda · Условные обозначения

	Hoisting · Sollevamento · Heben · Levage · Elevación · Elevação · Подъем
	Trolleying · Traslazione carrello · Katzfahren · Distribution · Distribución · Distribuição · Передвижение каретки
	Slewing · Rotazione · Schwenken · Orientation · Orientació · Giro · Поворот
	Travelling · Traslazione · Schienenfahren · Translation · Traslación · Móvel · Передвижение
	Directive on noise level · Direttiva sul livello acustico · Richtlinie für den Schall-Leistungspegel · Directive sur le niveau acoustique · Directiva sobre el nivel acustico · Directiva sobre nivel de ruidos · Директива по уровню шума
	Consult us · Consultateci · Auf Anfrage · Nous consulter · Consultarnos · Consulte-nos · Проконсультироваться с нами
	Power requirements · Potenza totale richiesta · Geforderte Stromstärke · Puissance totale nécessaire · Potencia necesaria · Requisitos de energia · Требования по питанию
	Power supply · Alimentazione · Stromversorgung · Alimentation · Alimentación · Fonte de alimentação · Питание
	With Terex Power Match · Con Terex Power Match · Mit Terex Power Match · Avec Terex Power Match · Con Terex Power Match · Com Terex Power Match · с Terex Power Match
	In service · In servizio · In Betrieb · En service · En servicio · Em serviço · При работе
	Out of service · Fuori servizio · Außer Betrieb · Hors service · Fuera de servicio · Fora de serviço · В режиме простоя
	Max. under hook height · Altezza max. sotto gancio · Höchste Hakenhöhe · Hauteur maxi. sous crochet · Maxima altura bajo gancho · Alt. máx. sob o gancho · Макс высота крюка
	Without load, without ballast, max. jib and max. height · A vuoto, senza zavorra, braccio max., altezza max. · Ohne Last und Ballast, mit Maximalausleger und Maximalhöhe · A vide, sans lest, avec flèche et hauteur maximum · Sin carga, sin lastre, con pluma y altura máxima · Sem carga, sem lastro, lança máxima, altura máxima · Без груза, без балласта, на макс. Длине вспомогательной стрелы и макс. Высоте
	Counterweight · Zavorra controbraccio · Gegengewicht · Lest de contre-flèche · Lastre de contra flecha · Contrapeso · Противовес
<b>C25</b>	EN 14439-C25

# CONTENTS

СТТ 202-10

Indice · Inhalt · Contenu · Contenido · Sumário · Содержание

Page · Pagina · Seite · Page · Página · Página · Страница:

<b>Load Diagram · Diagramma di portata · Lastkurven · Courbes de charges · Curvas de cargas · Diagrama de carga · Диаграмма грузоподъёмности</b> .....	<b>4</b>
<b>Tower · Torre · Turm · Tour · Torre · Torre · Башня</b> .....	<b>8</b>
<b>Mechanisms · Meccanismi · Antriebe · Mécanismes · Mecanismos · Mecanismo · Механизм</b> .....	<b>14</b>
<b>Transportation · Trasporto · Transport · Transport · Transporte · Transporte · Транспортировка</b> .....	<b>15</b>

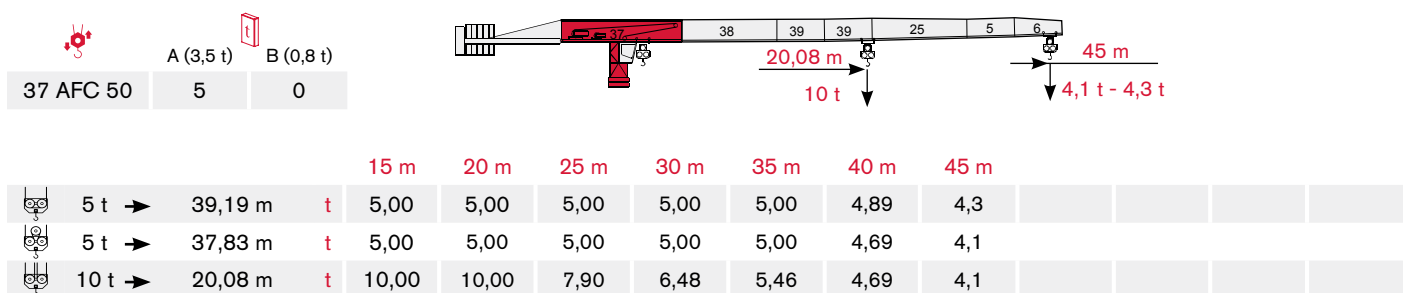
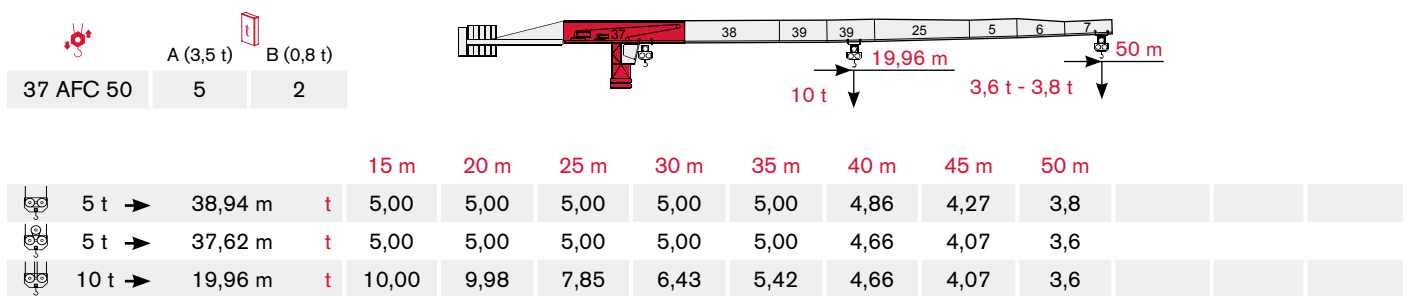
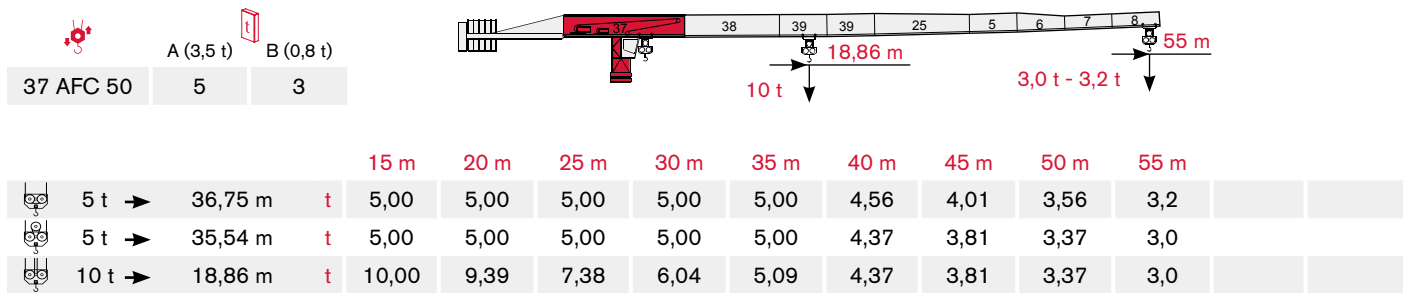
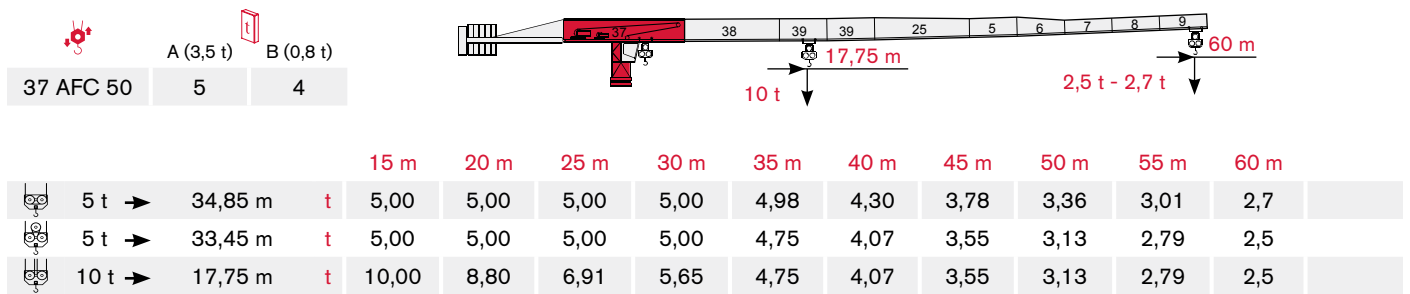
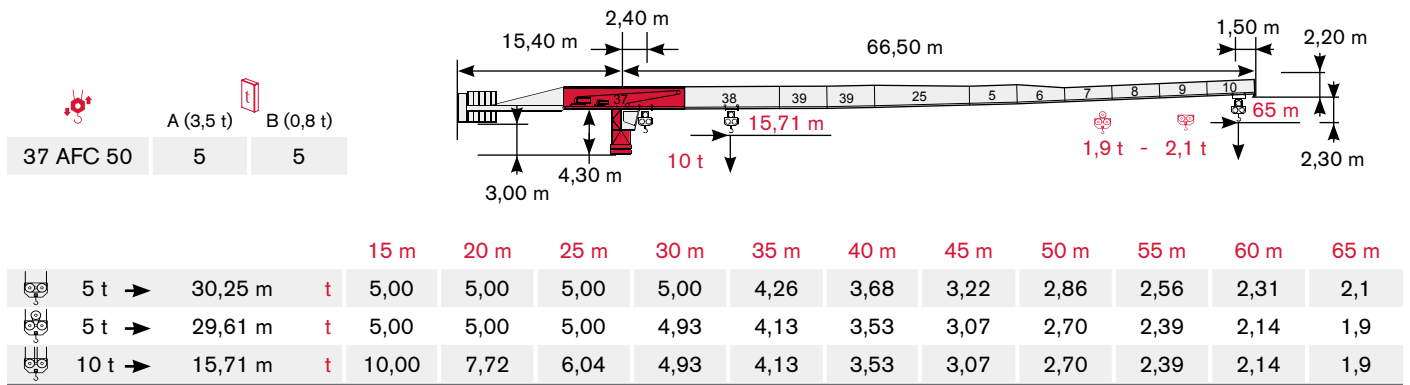

# LOAD DIAGRAM

Diagramma di portata · Lastkurven · Courbes de charges · Curvas de cargas · Diagrama de carga · Диаграмма грузоподъёмности

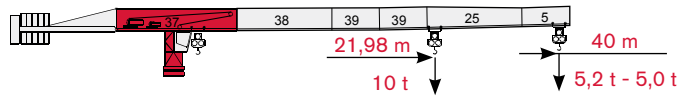

	A (3,5 t)	B (0,8 t)
37 AFC 50	4	3



			15 m	20 m	25 m	30 m	35 m	40 m						
	5 t →	40,00 m	t	5,00	5,00	5,00	5,00	5,00	5,0					
	5 t →	40,00 m	t	5,00	5,00	5,00	5,00	5,00	5,0					
	10 t →	21,98 m	t	10,00	10,00	8,71	7,15	6,04	5,2					

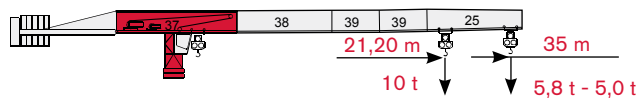

	A (3,5 t)	B (0,8 t)
37 AFC 50	4	1



			15 m	20 m	25 m	30 m	35 m							
	5 t →	35,00 m	t	5,00	5,00	5,00	5,00	5,0						
	5 t →	35,00 m	t	5,00	5,00	5,00	5,00	5,0						
	10 t →	21,20 m	t	10,00	10,00	8,38	6,88	5,8						

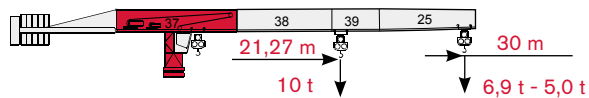

	A (3,5 t)	B (0,8 t)
37 AFC 50	3	3

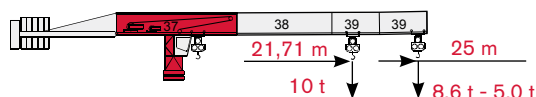

			15 m	20 m	25 m	30 m								
	5 t →	30,00 m	t	5,00	5,00	5,00	5,0							
	5 t →	30,00 m	t	5,00	5,00	5,00	5,0							
	10 t →	21,27 m	t	10,00	10,00	8,41	6,9							

	A (3,5 t)	B (0,8 t)
37 AFC 50	3	2



			15 m	20 m	25 m									
	5 t →	25,00 m	t	5,00	5,00	5,0								
	5 t →	25,00 m	t	5,00	5,00	5,0								
	10 t →	21,71 m	t	10,00	10,00	8,6								

# LOAD DIAGRAM

Diagramma di portata · Lastkurven · Courbes de charges · Curvas de cargas · Diagrama de carga · Диаграмма грузоподъёмности

## TEREX POWER PLUS

	A (3,5 t)	B (0,8 t)
37 AFC 50	5	5

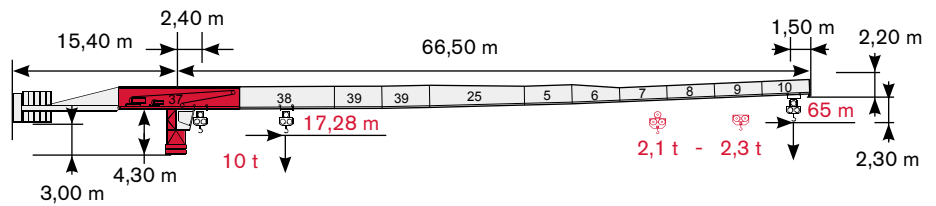

			15 m	20 m	25 m	30 m	35 m	40 m	45 m	50 m	55 m	60 m	65 m		
	5 t →	33,28 m	t	5,00	5,00	5,00	5,00	4,73	4,09	3,59	3,19	2,86	2,58	2,33	T P P
	5 t →	32,57 m	t	5,00	5,00	5,00	5,00	4,61	3,95	3,44	3,03	2,70	2,42	2,13	
	10 t →	17,28 m	t	10,00	8,55	6,71	5,48	4,61	3,95	3,44	3,03	2,70	2,42	2,13	

	A (3,5 t)	B (0,8 t)
37 AFC 50	5	4

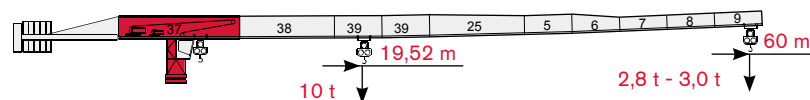

			15 m	20 m	25 m	30 m	35 m	40 m	45 m	50 m	55 m	60 m		
	5 t →	38,34 m	t	5,00	5,00	5,00	5,00	5,00	4,77	4,20	3,73	3,36	3,03	T P P
	5 t →	36,80 m	t	5,00	5,00	5,00	5,00	5,00	4,55	3,97	3,51	3,13	2,77	
	10 t →	19,52 m	t	10,00	9,75	7,67	6,28	5,29	4,55	3,97	3,51	3,13	2,77	

	A (3,5 t)	B (0,8 t)
37 AFC 50	5	3

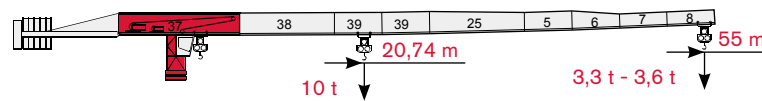

			15 m	20 m	25 m	30 m	35 m	40 m	45 m	50 m	55 m		
	5 t →	40,43 m	t	5,00	5,00	5,00	5,00	5,00	5,00	4,45	3,96	3,55	T P P
	5 t →	39,09 m	t	5,00	5,00	5,00	5,00	5,00	4,87	4,26	3,77	3,33	
	10 t →	20,74 m	t	10,00	10,00	8,19	6,71	5,66	4,87	4,26	3,77	3,33	

	A (3,5 t)	B (0,8 t)
37 AFC 50	5	2

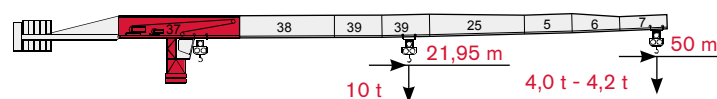

			15 m	20 m	25 m	30 m	35 m	40 m	45 m	50 m		
	5 t →	42,83 m	t	5,00	5,00	5,00	5,00	5,00	5,00	4,74	4,22	T P P
	5 t →	41,38 m	t	5,00	5,00	5,00	5,00	5,00	5,00	4,54	4,00	
	10 t →	21,95 m	t	10,00	10,00	8,70	7,14	6,03	5,19	4,54	4,00	

	A (3,5 t)	B (0,8 t)
37 AFC 50	5	0

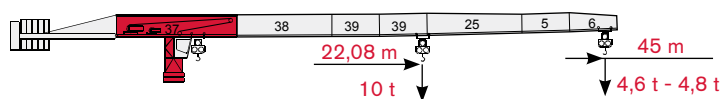

			15 m	20 m	25 m	30 m	35 m	40 m	45 m		
	5 t →	43,11 m	t	5,00	5,00	5,00	5,00	5,00	5,00	4,77	T P P
	5 t →	22,08 m	t	5,00	5,00	5,00	5,00	5,00	5,00	4,55	
	10 t →	22,08 m	t	10,00	10,00	8,76	7,19	6,07	5,23	4,55	



# TOWER

Torre · Turm · Tour · Torre · Torre · Башня

Standard Configurations · Installazioni Standard · Standardkonfiguration · Standard Implantations · Implantaciones Standard · Configuração padrão · Стандартная конфигурация крана

## TS16

Tower: TS16 & Basement: R1

	●	◊
R1	-1620 kN	-1940 kN
R2	1270 kN	1590 kN
	470 kN	

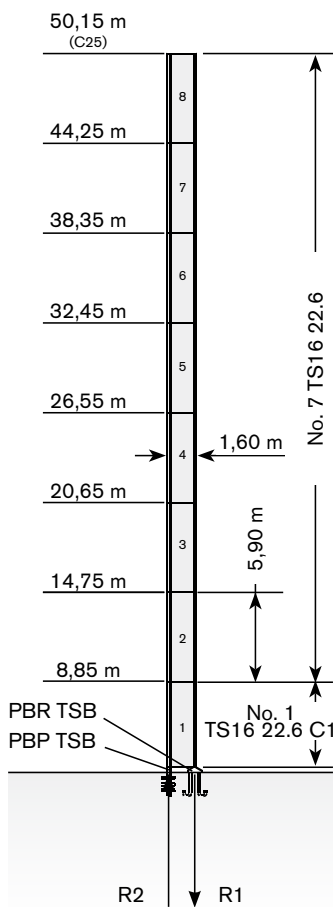

	max. H (m)	
	FEM 1001	FEM 1005 C25
25->45 m	50,15	50,15
50->65 m	50,15	50,15

Tower: TS16 & Basement: F1

	●	◊
R1	-1070 kN	-1320 kN
R2	0 kN	0 kN
	510 kN	

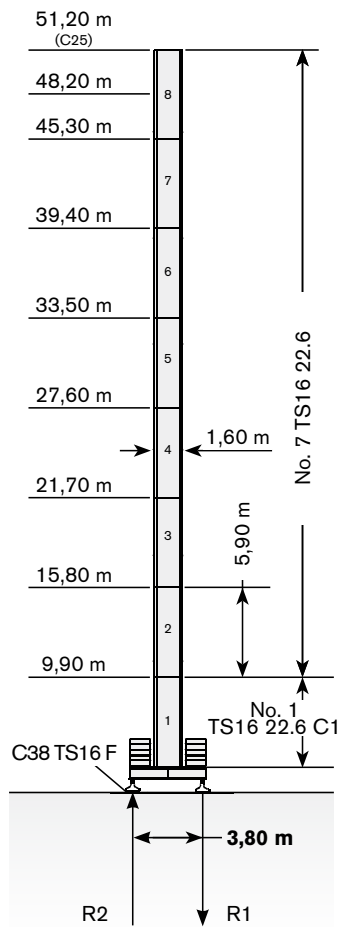

	max. H (m)	
	FEM 1001	FEM 1005 C25
25->45 m	48,20	48,20
50->65 m	51,20	51,20

Tower: TS16 & Basement: FP1

	●	◊
R1	-1070 kN	-1320 kN
R2	0 kN	0 kN
	510 kN	

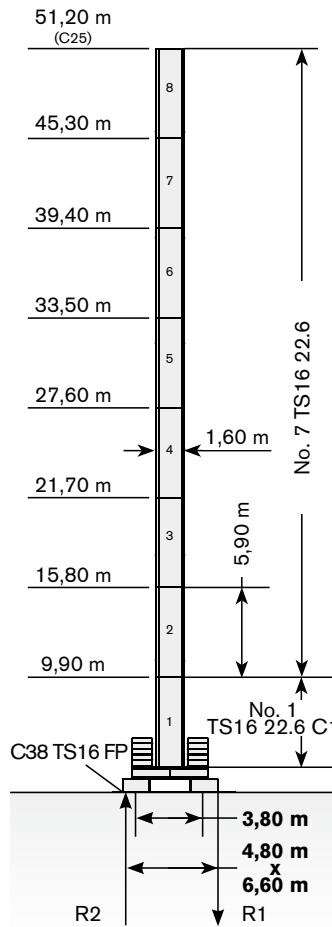

	max. H (m)	
	FEM 1001	FEM 1005 C25
25->45 m	51,20	51,20
50->65 m	51,20	51,20

Tower: TS16 & Basement: T1

	●	◊
R1	-1130 kN	-1140 kN
R2	0 kN	0 kN
	490 kN	

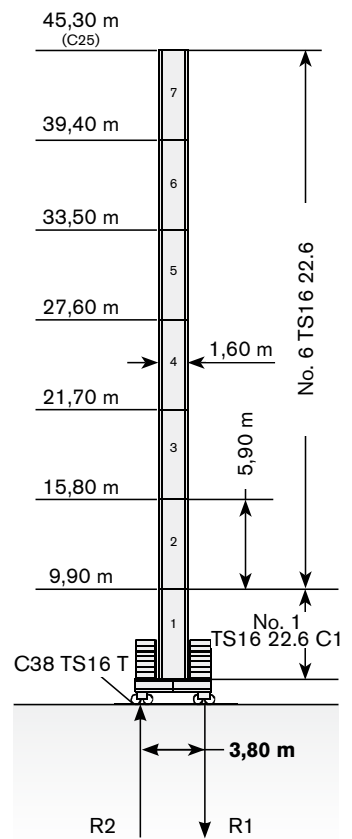

	max. H (m)	
	FEM 1001	FEM 1005 C25
25->45 m	45,30	45,30
50->65 m	45,30	45,30

Max. under hook height · Altezza max. sotto gancio · Höchste Hakenhöhe · Hauteur maxi. sous crochet · Maxima altura bajo gancho · alt. máx. sob o gancho · макс высота крюка

Different heights and tower combinations are available; please consult us · Altezze diverse e combinazioni di torre sono disponibili; consultateci · Andere Höhen und Turmkombinationen auf Anfrage · Différentes hauteurs et combinaisons de tour sont disponibles; nous consulter · Hay diferentes alturas y combinaciones de torre disponibles. Consúltenos · Diferentes alturas e combinações de torres disponíveis; fale conosco · Возможны другие сочетания высоты и конфигурации башни; проконсультируйтесь с нами



Tower: TS16 & Basement: F2

	●	◊
R1	-910 kN	-1130 kN
R2	0 kN	0 kN
	530 kN	

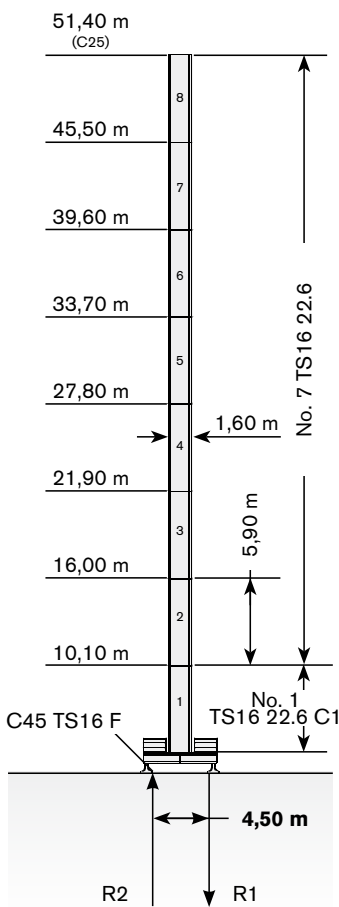

	max. H (m)	
	FEM 1001	FEM 1005 C25
25->45 m	51,40	51,40
50->65 m	51,40	51,40

Tower: TS16 & Basement: FP2

	●	◊
R1	-910 kN	-1130 kN
R2	0 kN	0 kN
	530 kN	

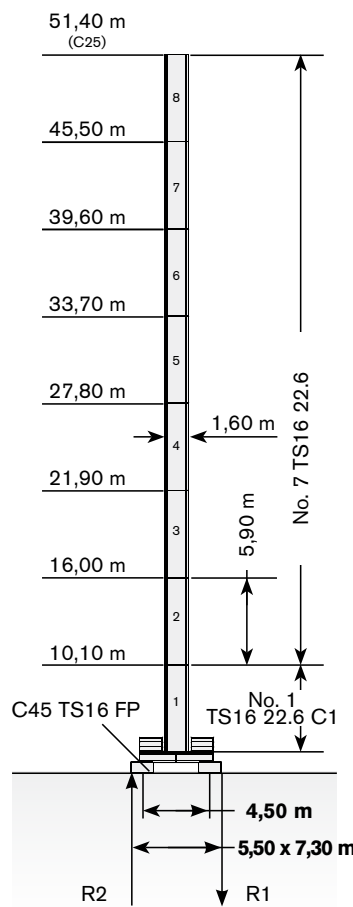

	max. H (m)	
	FEM 1001	FEM 1005 C25
25->45 m	51,40	51,40
50->65 m	51,40	51,40

Tower: TS16 & Basement: T2

	●	◊
R1	-960 kN	-980 kN
R2	0 kN	0 kN
	510 kN	

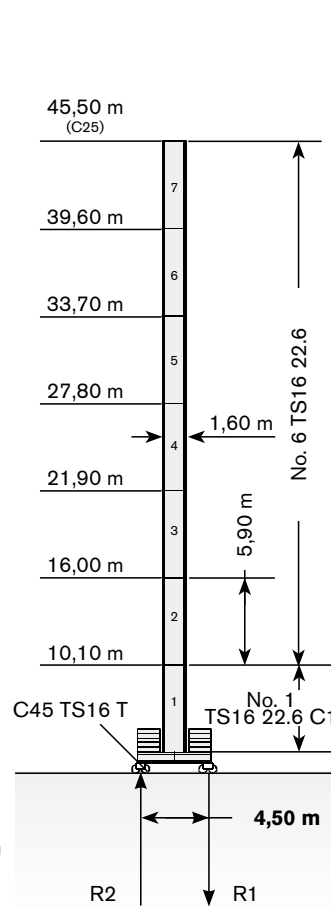

	max. H (m)	
	FEM 1001	FEM 1005 C25
25->45 m	45,50	45,50
50->65 m	45,50	45,50

The available lengths for the TS tower sections are 11.8 m, 5.9 m, 2.95 m. · Le prolunghie TS sono disponibili in lunghezza 11.8 m, 5.9 m, 2.95 m. · Die Turmschüsse TS sind mit Längen 11.8 m, 5.9 m, 2.95 m verfügbar. · Les éléments de mât TS sont disponibles en longueur 11.8 m, 5.9 m, 2.95 m. · Los tramos de torre TS son disponibles en las medidas de largo 11.8 m, 5.9 m, 2.95 m. · Os comprimentos disponíveis para elementos de torre TS são: 11.8m, 5.9m e 2.95m. · Длина поставляемых секций башни TS - 11.8 м, 5.9 м, 2.95 м.

Modular base chassis is also available; please consult us · E' anche disponibile il carro modulare; consultateci · Modulares Fundamentkreuz auf Anfrage · Châssis modifiable est disponible; nous consulter · La base modular está disponible. Consultémos · A base modular está disponível; fale conosco · модульная база доступна. проконсультируйтесь с нами

# TOWER

Torre · Turm · Tour · Torre · Torre · Башня

Standard Configurations · Installazioni Standard · Standardkonfiguration · Standard Implantations · Implantaciones Standard · Configuração padrão · Стандартная конфигурация крана

## TS21

Tower: TS21 & Basement: R2

R1	-1620 kN	-2080 kN
R2	1190 kN	1710 kN
	740 kN	

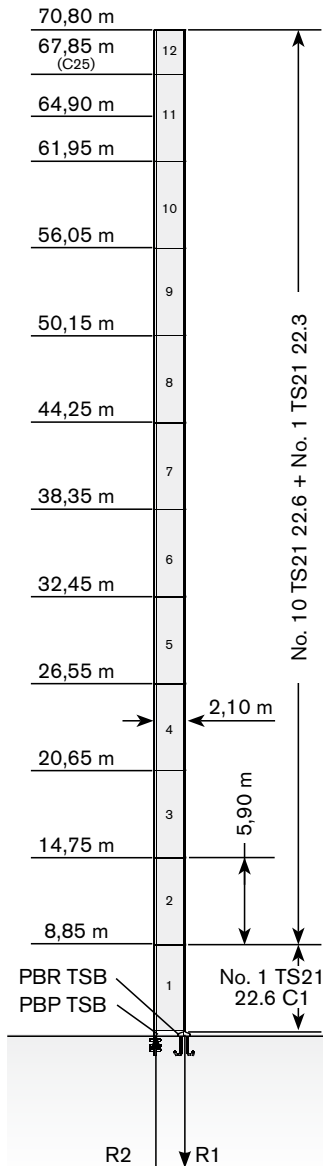

	max. H (m)	
	FEM 1001	FEM 1005 C25
25->45 m	70,80	67,85
50->65 m	70,80	64,90

Tower: TS21 & Basement: F3

R1	-940 kN	-1320 kN
R2	-30 kN	0 kN
	590 kN	

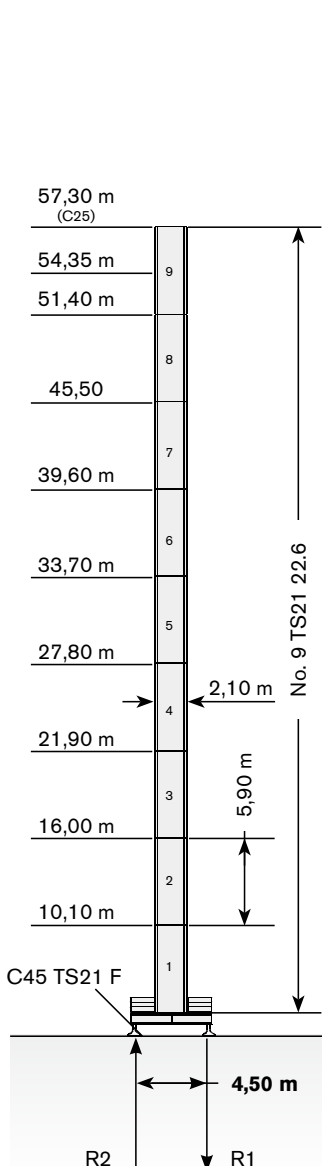

	max. H (m)	
	FEM 1001	FEM 1005 C25
25->45 m	54,35	54,35
50->65 m	57,30	57,30

Tower: TS21 & Basement: FP3

R1	-1010 kN	-1410 kN
R2	-42 kN	0 kN
	600 kN	

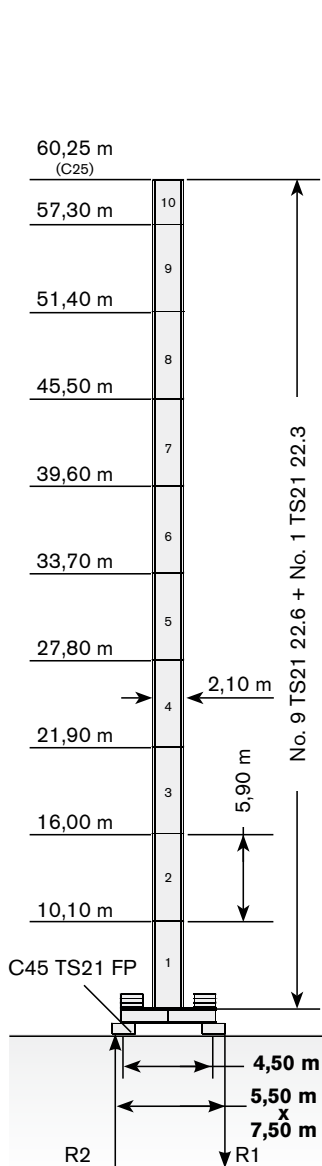

	max. H (m)	
	FEM 1001	FEM 1005 C25
25->45 m	57,30	57,30
50->65 m	60,25	60,25

Tower: TS21 & Basement: T3

R1	-1070 kN	-1320 kN
R2	0 kN	4460 kN
	590 kN	

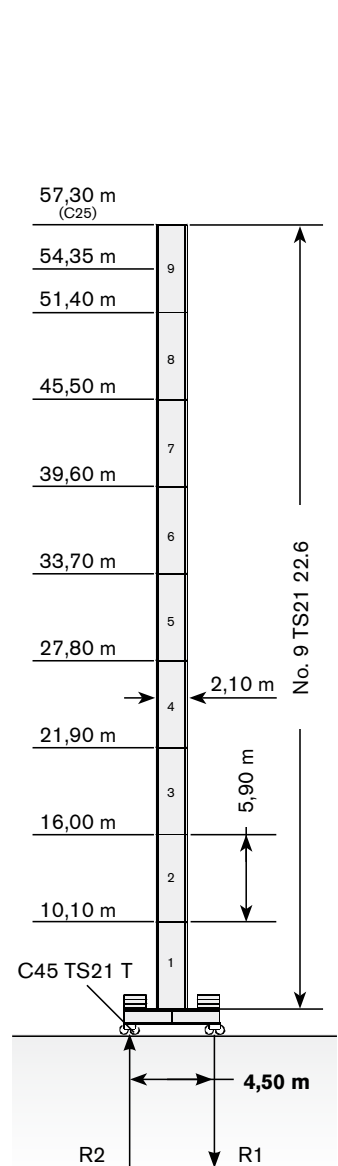

	max. H (m)	
	FEM 1001	FEM 1005 C25
25->45 m	54,35	54,35
50->65 m	57,30	57,30

Max. under hook height · Altezza max. sotto gancio · Höchste Hakenhöhe · Hauteur maxi. sous crochet · Maxima altura bajo gancho · alt. máx. sob o gancho · макс высота крюка

Tower: TS21 & Basement: F4

R1	-880 kN	-1130 kN
R2	-60 kN	0 kN
	660 kN	

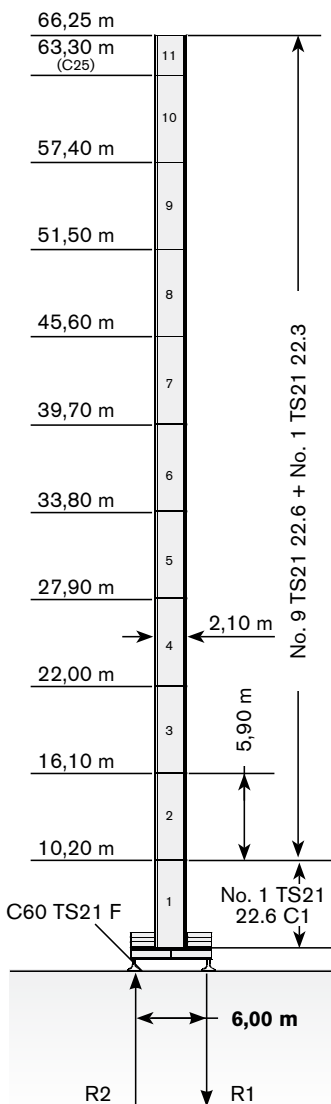

	max. H (m)	
	FEM 1001	FEM 1005 C25
25->45 m	66,25	63,30
50->65 m	66,25	63,30

Tower: TS21 & Basement: FP4

R1	-970 kN	-1220 kN
R2	-60 kN	0 kN
	680 kN	

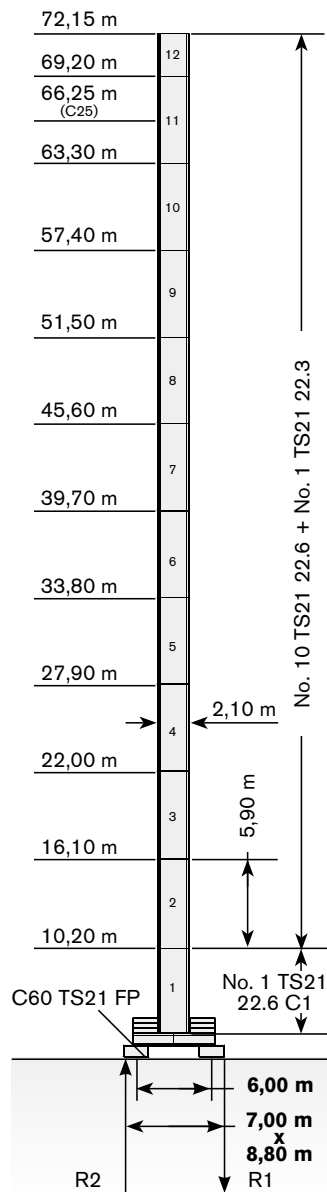

	max. H (m)	
	FEM 1001	FEM 1005 C25
25->45 m	72,15	66,25
50->65 m	72,15	63,30

Tower: TS21 & Basement: T4

R1	-940 kN	-1130 kN
R2	0 kN	0 kN
	640 kN	

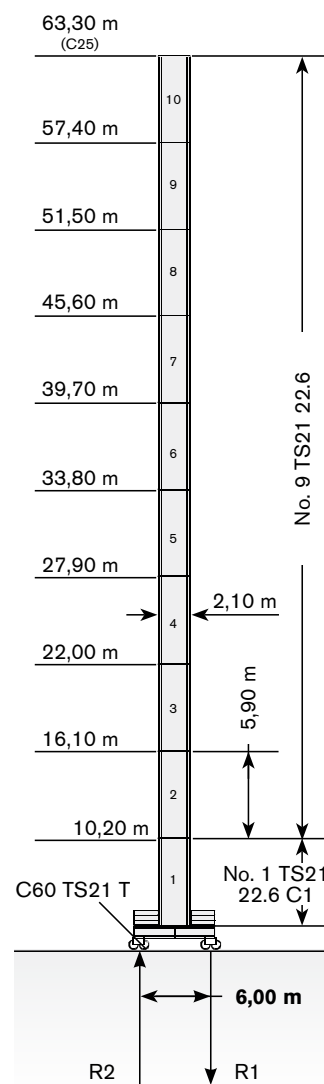

	max. H (m)	
	FEM 1001	FEM 1005 C25
25->45 m	63,30	63,30
50->65 m	63,30	63,30

The available lengths for the TS tower sections are 11.8 m, 5.9 m, 2.95 m. · Le prolunghe TS sono disponibili in lunghezze 11.8 m, 5.9 m, 2.95 m. · Die Turmschüsse TS sind mit Längen 11.8 m, 5.9 m, 2.95 m verfügbar. · Les éléments de mât TS sont disponibles en longueur 11.8 m, 5.9 m, 2.95 m. · Los tramos de torre TS son disponibles en las medidas de largo 11.8 m, 5.9 m, 2.95 m. · Os comprimentos disponíveis para elementos de torre TS são: 11.8m, 5.9m e 2.95m. · Длина поставляемых секций башни TS - 11.8 м, 5.9 м, 2.95 м. · Modular base chassis is also available; please consult us · E' anche disponibile il carico modulare; consultateci · Modulares Fundamentkreuz auf Anfrage · Châssis modifiable est disponible; nous consulter · La base modular está disponible. Consultémos · A base modular está disponível; fale conosco · модульная база доступна. проконсультируйтесь с нами

**WORKS FOR YOU.™**

# TOWER

Torre · Turm · Tour · Torre · Torre · Башня

Standard Configurations · Installazioni Standard · Standardkonfiguration · Standard Implantations · Implantaciones Standard · Configuração padrão · Стандартная конфигурация крана

## H20

Tower: H20 & Basement: RTL

R1	-2024 kN	-3333 kN
R2	1435 kN	2829 kN
	1057 kN	

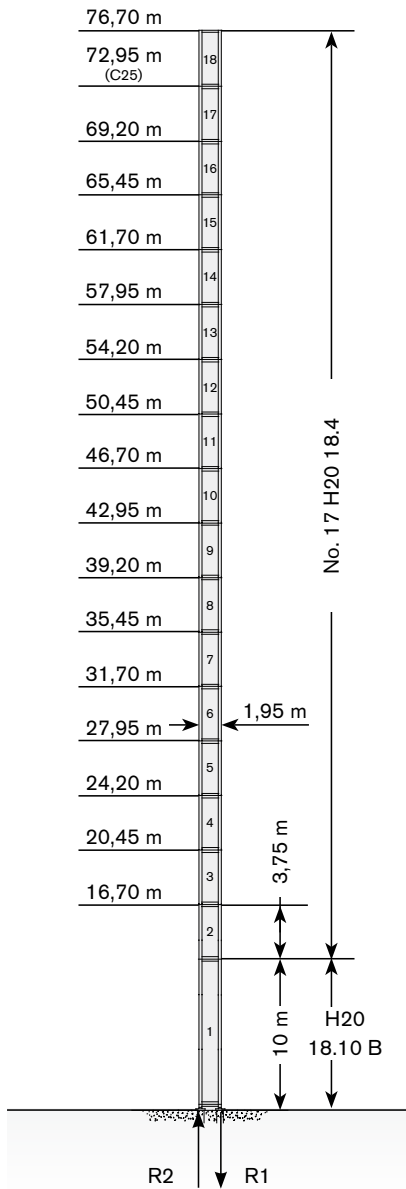

Tower: H20 & Basement: FTR

R1	-1173 kN	-1711 kN
R2	-346 kN	0 kN
	1098 kN	

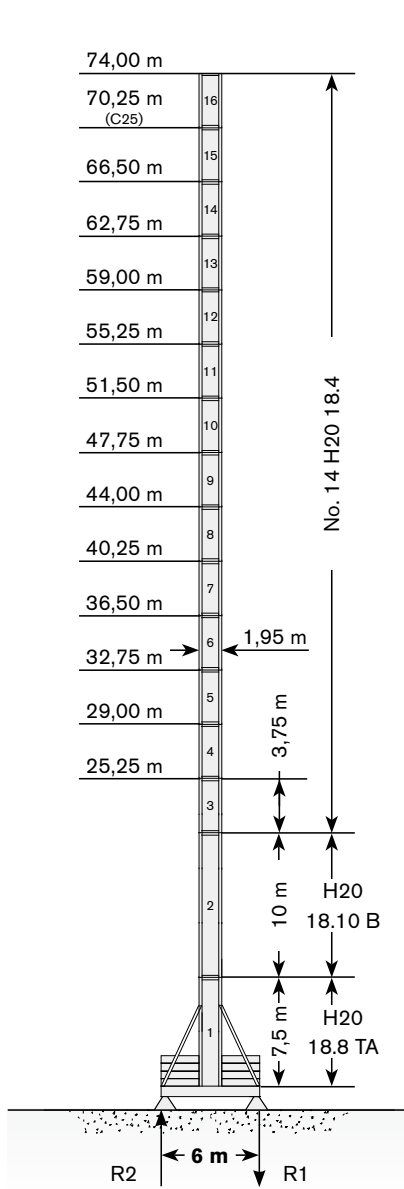

Tower: H20 & Basement: TTR

R1	-1280 kN	-1711 kN
R2	-145 kN	0 kN
	1098 kN	

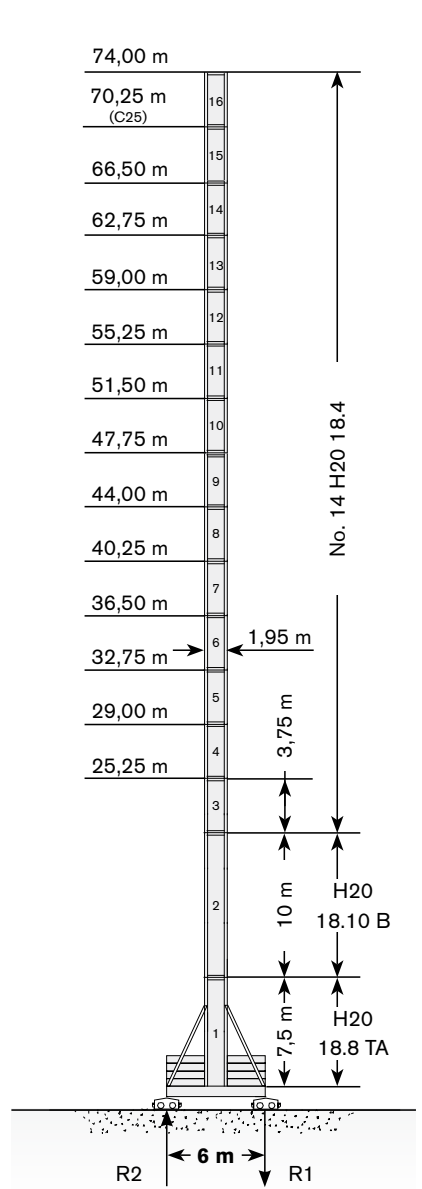

Max. under hook height · Altezza max. sotto gancio · Höchste Hakenhöhe · Hauteur maxi. sous crochet · Maxima altura bajo gancho · alt. máx. sob o gancho · макс высота крюка

Different heights and tower combinations are available; please consult us · Altezze diverse e combinazioni di torre sono disponibili; consultateci · Andere Höhen und Turmkombinationen auf Anfrage · Différentes hauteurs et combinaisons de tour sont disponibles; nous consulter · Hay diferentes alturas y combinaciones de torre disponibles. Consúltenos · Diferentes alturas e combinações de torres disponíveis; fale conosco · Возможны другие сочетания высоты и конфигурации башни; проконсультируйтесь с нами

**Other configurations · Altre Installazioni · Aufstellmöglichkeiten ·  
Autres Implantations · Otras Implantaciones · Outras configurações ·  
Другие конфигурации**

Bottom climbing crane · Gru climbing · Kletterkran im Gebäude · Télescope sur dalles · Telescopiaje grúa trepadora · Guindaste automontante interno · Самоподъемный кран

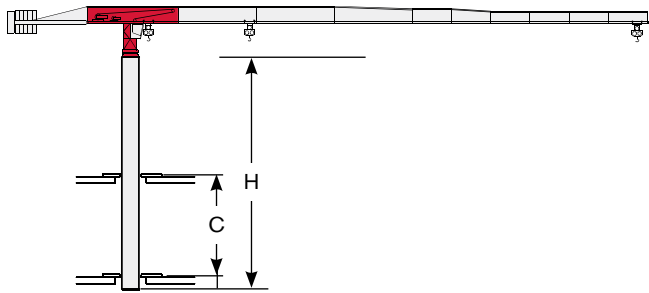

Tower: TS16

Jib	C min/max (m)	H min/max (m)
		<b>i</b>

Tower: TS21

Jib	C min/max (m)	H min/max (m)
all	11/14	29,5/41,3

Tower: H20

Jib	C min/max (m)	H min/max (m)
all		<b>i</b>

Crane tied to the structure · Gru ancorata · Geankerter Kran · Grue ancrée · Grúa anclada · Guindaste ancorado na estrutura · Кран, крепящийся к сооружению

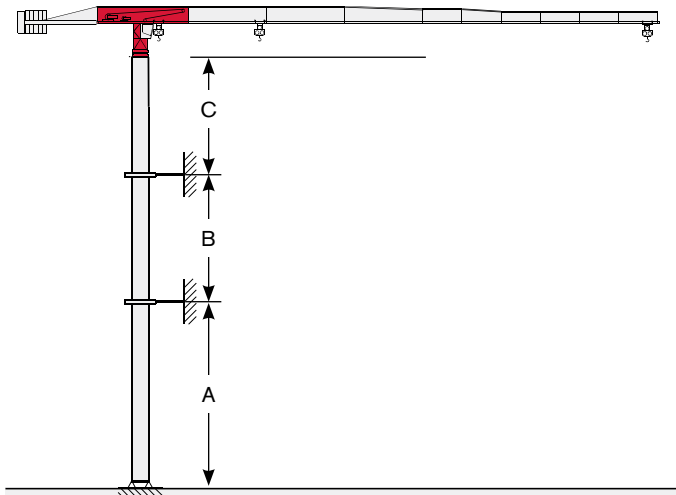

Tower: TS16

Jib	A min/max (m)	B min/max (m)	C max (m)
all			<b>i</b>

Tower: TS21

Jib	A min/max (m)	B min/max (m)	C max (m)
all	48/54	23/32	35

Tower: H20

Jib	A min/max (m)	B min/max (m)	C max (m)
all	48/54	18/28	40

# MECHANISMS

Meccanismi · Antriebe · Mécanismes · Mecanismos · Mecanismo · Механизм

Power supply · Alimentazione · Stromversorgung · Alimentation · Suministro eléctrico · Requisitos de energia · Требования по питанию

	37 AFC 50	36* → 60 kVA	400V - 50Hz / 460V - 60Hz	2000/14/CE modificata
--	-----------	--------------	---------------------------	-----------------------

\* - kVA +

Hoisting · Sollevamento · Heben · Levage · Elevación · Elevação · Подъем

			t	m/min	kW	
	37 AFC 50		5	0 → 36	37	
			3,5	0 → 50		
			3	0 → 57		
			2	0 → 80		
			1,25	0 → 110		
			10	0 → 18		
			7	0 → 25		
			6	0 → 28		
			4	0 → 40		
			2,5	0 → 55		

Hoisting Speed · Velocità di Sollevamento · Heben Geschwindigkeit · Vitesse de Levage · Velocidad de Elevación · Velocidade de içamento · Скорость подъема

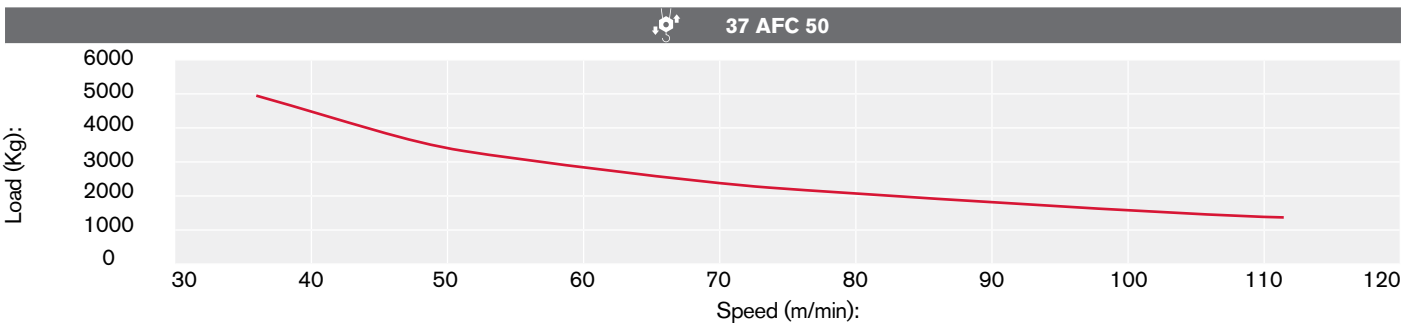

Additional Specifications · Altre movimentazioni · Weitere Leistungsdaten · Spécifications additionnelles · Otras prestaciones · Especificações adicionais · Дополнительные спецификации

	DVF 3 6	0 → 40 → 80 m/min	5,5 kW
	SVF 2 2 6	0,7 r.p.m	2 x 5,5 kW
	TAD 2RP 2M4	0 → 24 m/min	2 x 4 kW
	TAD 2RG 4M3	0 → 24 m/min	4 x 3 kW
	<b>i</b>		

Tower height max.

		T3	T4
	TAD 2RP 2M4	39,10 m	32,90 m
	TAD 2RG 4M3	> 39,10 m	> 32,90 m



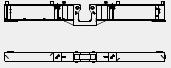
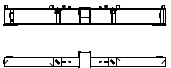
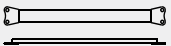
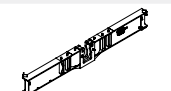
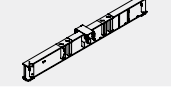
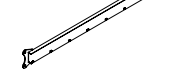
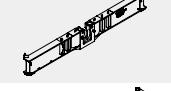
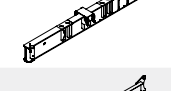
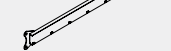

## Packing list

### Undercarriage

CTT 202-10	DESCRIPTION · DESCRIZIONE · BESCHREIBUNG · DESCRIPTION · DESCRIPCIÓN · DESCRIÇÃO · ОПИСАНИЕ	LENGTH · LUNGHEZZA · LÄNGE · LONGUEUR · LONGITUD · COMPRIMENTO · ДЛИНА	WIDTH · LARGHEZZA · BREITE · LARGEUR · ANCHURA · LARGURA · ШИРИНА	HEIGHT · ALTEZZA · HÖHE · HAUTEUR · ALTURA · ALTURA · ВЫСОТА	QUANTITY · QUANTITÀ · MENGE · QUANTITÉ · CANTIDAD · QUANTIDADE · КОЛИЧЕСТВО	WEIGHT · PESO · GEWICHT · POIDS · PESO · PESO · ВЕС
	UNDERCARRIAGE C38 TS16 BEAM "A"	5,8 m	0,41 m	0,8 m	1	2050 kg
	UNDERCARRIAGE C38 TS16 BEAM "B"	5,8 m	0,75 m	0,7 m	1	2050 kg
	UNDERCARRIAGE C38 TS16 CROSSBEAM (T)	3,7 m	0,11 m	0,4 m	1	190 kg
	BEAM "A" FOR UNDERCARRIAGE C45 TS21-TS16	6,80 m	0,40 m	1,00 m	1	2820 kg
	BEAM "B" FOR UNDERCARRIAGE C45 TS21-TS16	6,80 m	0,75 m	0,80 m	1	2620 kg
	CROSSBEAMS UNDERCARRIAGE C45 TS21-TS16 (T)	4,40 m	0,12 m	0,54 m	2	230 kg
	"A" BEAM FOR UNDERCARRIAGE C60	8,90 m	0,40 m	1,10 m	1	3600 kg
	"B" BEAM FOR UNDERCARRIAGE C60	8,90 m	0,70 m	0,90 m	1	3600 kg
	CROSSBEAM FOR UNDERCARRIAGE C60 (T)	5,90 m	0,60 m	0,20 m	2	450 kg

### Tower

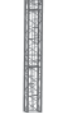







CTT 202-10 TS16

	TOWER SECTION TS16 22.3	1,6 m	1,60 m	2,98 m	1	1215 kg*
	TOWER SECTION TS16 22.6	1,6 m	1,6 m	5,93 m	1	2260 kg*
	TOWER SECTION TS16 22.12	1,6 m	1,6 m	11,83 m	1	4400 kg*
	SLEWING UNIT TS16	2,01 m	1,99 m	1,63 m	1	4400 kg

\* Complete with ladder, support and ladder guard, platform

# TRANSPORTATION



Trasporto · Transport · Transport · Transporte · Transporte · Транспортировка

CTT 202-10 TS21	DESCRIPTION · DESCRIZIONE · BESCHREIBUNG · DESCRIPTION · DESCRIPCIÓN · DESCRIÇÃO · ОПИСАНИЕ	LENGTH · LUNGHEZZA · LANGE · LONGUEUR · LONGITUD · COMPRIENTO · ДЛИНА	WIDTH · LARGHEZZA · BREITE · LARGEUR · ANCHURA · LARGURA · ШИРИНА	HEIGHT · ALTEZZA · HÖHE · HAUTEUR · ALTURA · ALTURA · · ВЪСОТА	QUANTITY · QUANTITÀ · MENGE · QUANTITÉ · · CANTIDAD · QUANTIDADE · КОЛИЧЕСТВО	WEIGHT · PESO · GEWICHT · POIDS · PESO · PESO · BEC
	TS21 22.3 TOWER SECTION	2,10 m	2,10 m	2,98 m	1	1382 kg*
	TS21 22.6 TOWER SECTION	2,10 m	2,10 m	5,93 m	1	2550 kg*
	TS21 22.12 TOWER SECTION	2,07 m	2,10 m	11,80 m	1	4825 kg
	TS21 22.6 C1 TOWER SECTION	2,10 m	2,10 m	5,93 m	1	2800 kg*
	TS21 22.6 C2 TOWER SECTION	2,10 m	2,10 m	5,93 m	1	2611 kg*
	SLEWING UNIT TS21	2,21 m	2,49 m	1,63 m	1	5200 kg
<b>CTT 202-10 H20</b>						
	TOWER SECTION HA20 18.10 B	10 m	2 m	1,95 m	1	7000 kg*
	TOWER SECTION HA20 18.4 B	3,75 m	2 m	1,95 m	1	2955 kg*
	SLEWING UNIT H20	2,26 m	2,26 m	2,06 m	1	5530 kg





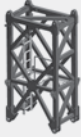

\* Complete with ladders, plat forms and assembly equipment



## Cab

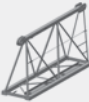

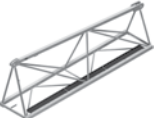

CTT 202-10	DESCRIPTION · DESCRIZIONE · BESCHREIBUNG · DESCRIPTION · DESCRIPCIÓN · DESCRIÇÃO · ОПИСАНИЕ	LENGTH · LUNGHEZZA · LANGE · LONGUEUR · LONGITUD · COMPRIMENTO · ДЛИНА	WIDTH · LARGHEZZA · BREITE · LARGEUR · ANCHURA · LARGURA · ШИРИНА	HEIGHT · ALTEZZA · HÖHE · HAUTEUR · ALTURA · ALTURA · · ВЬСОТА	QUANTITY · QUANTITÀ · MENGE · QUANTITÉ · · CANTIDAD · QUANTIDADE · КОЛИЧЕСТВО	WEIGHT · PESO · GEWICHT · POIDS · PESO · PESO · BEC
	CAB SECTION	1,82 m	1,38 m	3,50 m	1	2000 kg
	CAB UNIT PLATFORM	3,30 m	1,80 m	2,40 m	1	1230 kg

## Upper Part

	JIB SECTION 37	11,9 m	1,77 m	2,33 m	1	6500 kg
	JIB SECTION - 38	10,3 m	1,11 m	2,23 m	1	2400 kg
	JIB SECTION - 39	5,30 m	1,11 m	2,20 m	1	1010 kg
	JIB SECTION-25	10,3 m	1,11 m	1,80 m	1	1408 kg
	JIB SECTION-05	5,20 m	1,11 m	1,80 m	1	530 kg
	JIB SECTION-06	5,20 m	1,11 m	1,80 m	1	510 kg
	JIB SECTION-07	5,2 m	1,11 m	1,3 m	1	450 kg
	JIB SECTION-08	5,2 m	1,11 m	1,30 m	1	400 kg

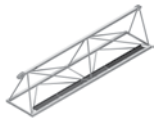
# TRANSPORTATION

Trasporto · Transport · Transport · Transporte · Transporte · Транспортировка

СТТ 202-10	DESCRIPTION · DESCRIZIONE · BESCHREIBUNG · DESCRIPTION · DESCRIPCIÓN · DESCRIÇÃO · ОПИСАНИЕ	LENGTH · LUNGHEZZA · LANGE · LONGUEUR · LONGITUD · COMPRIMENTO · ДЛИНА	WIDTH · LARGHEZZA · BREITE · LARGEUR · ANCHURA · LARGURA · ШИРИНА	HEIGHT · ALTEZZA · HÖHE · HAUTEUR · ALTURA · ALTURA · ВЫСОТА	QUANTITY · QUANTITÀ · MENGE · QUANTITÉ · CANTIDAD · QUANTIDADE · КОЛИЧЕСТВО	WEIGHT · PESO · GEWICHT · POIDS · PESO · PESO · BEC
	JIB SECTION-09	5,2 m	1,11 m	1,30 m	1	300 kg
	JIB SECTION-10	5,2 m	1,11 m	1,30 m	1	285 kg
	COUNTERJIB	9,70 m	1,40 m	0,80 m	1	2300 kg
	JIB TROLLEY AND HOIST BLOCKS	1,35 m	1,60 m	0,90 m	1	598 kg
	HOIST BLOCK	0,85 m	0,36 m	0,95 m	1	328 kg
	QEG GENERAL ELECTRICAL BOX PLATFORM	2,38 m	1,57 m	1,78 m	1	770 kg



# TEREX TOWER CRANES

## Gru Comedil Srl

Via delle Innovazioni, 17  
33074 Fontanafredda (PN)  
Italy  
Ph: +39 0434 989111  
Email: mktg.cranes@terex.com

September 2022. Product specifications and prices are subject to change without notice or obligation. The photographs and/or drawings in this document are for illustrative purposes only. Refer to the appropriate Operator's Manual for instructions on the proper use of this equipment. Failure to follow the corresponding Operator's Manual when using our equipment or to otherwise act responsibly may result in serious injury or death. The only warranty applicable to our equipment is the standard written warranty applicable to the particular product and sale and Terex makes no other warranty, express or implied. Products and services listed may be trademarks, service marks or trade-names of Terex Corporation and/or its subsidiaries in the USA and other countries. All rights are reserved. Terex, the Terex Crown design and Works For You are trademarks of Terex Corporation or its subsidiaries.

Settembre 2022. Specifiche e prezzi dei prodotti sono soggetti a modifica senza preavviso o altro obbligo. Le fotografie e i disegni in questo documento hanno esclusivamente scopo illustrativo. Consulta il Manuale dell'operatore pertinente per trovare istruzioni per l'utilizzo corretto di questo macchinario. La mancata osservanza delle istruzioni contenute nel relativo Manuale dell'operatore durante l'uso del macchinario e altri comportamenti irresponsabili possono provocare gravi lesioni, anche mortali. L'unica garanzia applicabile ai nostri macchinari è la garanzia scritta standard applicabile al particolare prodotto e alla particolare vendita e Terex è esonerata dal fornire qualsiasi altra garanzia, esplicita o implicita. I prodotti e servizi elencati possono essere dei marchi di fabbrica, marchi di servizio o nomi commerciali di Terex Corporation, e/o delle rispettive società affiliate negli Stati Uniti d'America e in molte altre nazioni. Tutti i diritti riservati. Terex, il marchio Terex Crown e Works for You sono marchi di proprietà di Terex Corporation o delle sue società affiliate.

September 2022. Irrtum und Änderungen der Produktspezifikationen vorbehalten. Die in diesem Dokument enthaltenen Fotos und/oder Zeichnungen dienen rein anschaulichen Zwecken. Für den sachgemäßen Gebrauch der Maschinen ist das entsprechende Bedienerhandbuch heranzuziehen. Unsachgemäßer Umgang mit bzw. unsachgemäßer Einsatz unserer Maschinen kann zu schweren gesundheitlichen Schäden bis hin zum Tod führen. Für unsere Produkte wird ausschließlich die entsprechende, schriftlich niedergelegte Standardgarantie gewährt. Terex leistet keinerlei darüber hinausgehende Garantie, weder ausdrücklich noch stillschweigend. Die genannten Produkte und Dienstleistungen sind in den USA und anderen Ländern ggf. Marken, Dienstleistungsmarken oder Handelsnamen der Terex Corporation und/oder ihrer Tochtergesellschaften. Alle Rechte vorbehalten. Terex, das Terex Kronenlogo und Works For You sind Marken in Eigentum der Terex Corporation bzw. ihrer Tochtergesellschaften.

Septembre 2022. Les caractéristiques et prix des produits peuvent faire l'objet de modifications sans notification préalable. Les photographies ou dessins présentés dans ce document servent uniquement à des fins d'illustration. Pour connaître les instructions relatives à l'utilisation correcte de cet équipement, veuillez vous référer au manuel de l'utilisateur correspondant. Le non-respect du manuel d'utilisateur correspondant lors de l'utilisation de notre équipement ou des actes irresponsables risquent de provoquer de graves blessures, voire un décès. La seule garantie applicable à nos équipements est la garantie écrite standard applicable au produit et à la vente spécifiques. Terex ne délivre aucune autre garantie, expresse ou implicite. Les produits et les services mentionnés peuvent être des marques, des marques de service ou des appellations commerciales de Terex Corporation et/ou de ses filiales aux États-Unis et dans d'autres pays. Tous droits réservés. Terex, le design Terex Crown et Works For You sont des marques déposées de Terex Corporation ou de ses filiales.

Septiembre 2022. Las especificaciones y los precios de los productos están sujetos a cambios sin necesidad de previo aviso ni ninguna otra obligación. Las fotografías y/o dibujos de este documento tienen un fin meramente ilustrativo. Consulte el correspondiente manual de instrucciones del operario para obtener más información sobre el uso correcto de esta maquinaria. No respetar el manual del operario al utilizar la maquinaria o actuar de forma irresponsable puede provocar lesiones graves e incluso mortales. La única garantía aplicable a nuestra maquinaria es la garantía escrita estándar de cada producto y venta. Terex no amplía dicha garantía de forma expresa ni implícita. Los productos y servicios mencionados pueden ser marcas comerciales, marcas de servicio o nombres de marca de Terex Corporation o de alguna de sus filiales en Estados Unidos y otros países. Todos los derechos reservados. Terex, el diseño de la corona Terex y Works For You son marcas registradas de Terex Corporation o de sus filiales.

Setembro 2022. Especificações e preços dos produtos sujeitos a alteração sem aviso prévio ou obrigações. As fotografias e/ou desenhos neste documento são apenas para fins ilustrativos. Consulte o respectivo Manual do Operador para instruções sobre o uso correto deste equipamento. Deixar de acompanhar o respectivo Manual do Operador ao usar o nosso equipamento ou, por qualquer outra forma, deixar de agir de maneira responsável pode resultar em lesões corporais graves ou a morte. A única garantia aplicável ao nosso equipamento é a garantia padrão por escrito correspondente ao produto específico vendido. A Terex não dá outras garantias, expressas ou implícitas. Os produtos e serviços listados podem ser marcas comerciais, marcas de serviço ou nomes-fantasia da Terex Corporation e/ou suas subsidiárias nos EUA e em outros países. Todos os direitos reservados. Terex, o desenho da Coroa Terex e a expressão Works For You são marcas comerciais da Terex Corporation ou suas subsidiárias.

Сентябрь 2022 г. года Технические характеристики и цены могут изменяться без предварительного уведомления и без каких-либо обязательств для производителя. Фотографии и (или) чертежи в настоящем документе служат только в качестве иллюстраций. Инструкции по надлежащей эксплуатации данного оборудования см. в соответствующем руководстве для оператора. Невыполнение указаний соответствующих руководств для оператора при эксплуатации оборудования или другие безответственные действия могут повлечь серьезные травмы или смерть. Единственной гарантией, действующей в отношении нашего оборудования, является стандартная форма письменной гарантии на данный тип оборудования и на условия его продажи. Terex не дает никаких других гарантий: ни ясно выраженных, ни подразумеваемых. Перечисленные продукты и услуги могут быть торговыми марками, знаками обслуживания или торговыми наименованиями Terex Corporation и / или ее дочерних компаний в США и других странах. Все права защищены. Terex, изображение короны Terex и Works for You являются торговыми марками, принадлежащими корпорации Terex или ее дочерним компаниям.



[www.terex.com/tower-cranes](http://www.terex.com/tower-cranes)

Brochure Reference: TC-DS-M-E/IG/F/S/P/R-CTT202-10-09/22



**WORKS FOR YOU.™**